



**BRAIME**

# A400 ELITE

TECHNOLOGY · INNOVATION · QUALITY · VALUE

## A400 ELITE Elevator Belt Alignment Monitoring System

**A4004V4CAI** - A400 Elite control unit

Supply: 12 to 24 DC

Ex II 2D T125°C zone 21 & 22

**A4004V46CAI** - A400 Elite control unit

Supply: 95 to 250VAC /12 to 24 DC

Ex II 3D T125°C zone 22

### APPLICATION

The A400 Elite is a control unit that detects dangerous misalignment of buckets and belt. The A400 Elite monitor works with up to four sensors (BAP2, WDA3 or WDA3HT) depending on the size and type of elevator. It monitors sensors mounted on the elevator that generate a pulse for each metallic bucket or bolt. If the elevator belt becomes misaligned, one of the probes will fail to detect the buckets or bolts, the control unit will cause the alarm relay to energise and, after a delay, the stop relay will de-energise.

### FEATURES

- ▶ The A400 Elite monitors the alignment of the belt in one elevator, at both the top and the bottom, or in two separate bucket elevators
- ▶ Alarm and Shut down Relays with time delay options
- ▶ Control unit LEDs indicate the running, alarm and shutdown status of each elevator
- ▶ Easy on-site Installation
- ▶ Full system test feature
- ▶ Voltage free relay contacts
- ▶ IP 66, Nema 12
- ▶ ATEX, IECEx & CSA Approved

### OPTIONS

- ▶ RS485 serial communication

Detailed specification, wiring diagrams and installation/operating instructions available upon request.



ATEX zones 21 & 22



CLASS 2 Div. 2  
Groups E,F, & G



**BRAIME**

# A400 ELITE

TECHNOLOGY · INNOVATION · QUALITY · VALUE

TECHNICAL SPECIFICATIONS		
Model	A4004V46CAI	A4004V4CAI
Approval	ATEX & IECEx Zone 22, Ex II 3D T125°C T amb -15 to +50°C BAS03ATEX0674X & CSA	ATEX & IECEx Zone 21Ex II 2D T125°C T amb -15 to +50°C BAS03ATEX0674X & CAI
Enclosure	Polycarbonate	
Supply	95 to 250 VAC 12 to 24 VDC	12 to 24 VDC
Rating	10 VA	
Protection	IP 66	
Contact relay ALARM	ALARM A: 1 contact NO 8 A 250 Vac ALARM B: 1 contact NO 8 A 250 Vac	
Contact relay STOP	STOP A: 1 contact NO 8 A 250 Vac STOP B: 1 contact NO 8 A 250 Vac	
Dimension	HxLxD :246x 188 x 102 mm	
Entry	2 drill dia. 28 mm	
Fixt point	222 x 102 mm	
Weight	1,3 Kg	

**BAP21V34CA**



**WDA3V34CA**



**WDA HT**

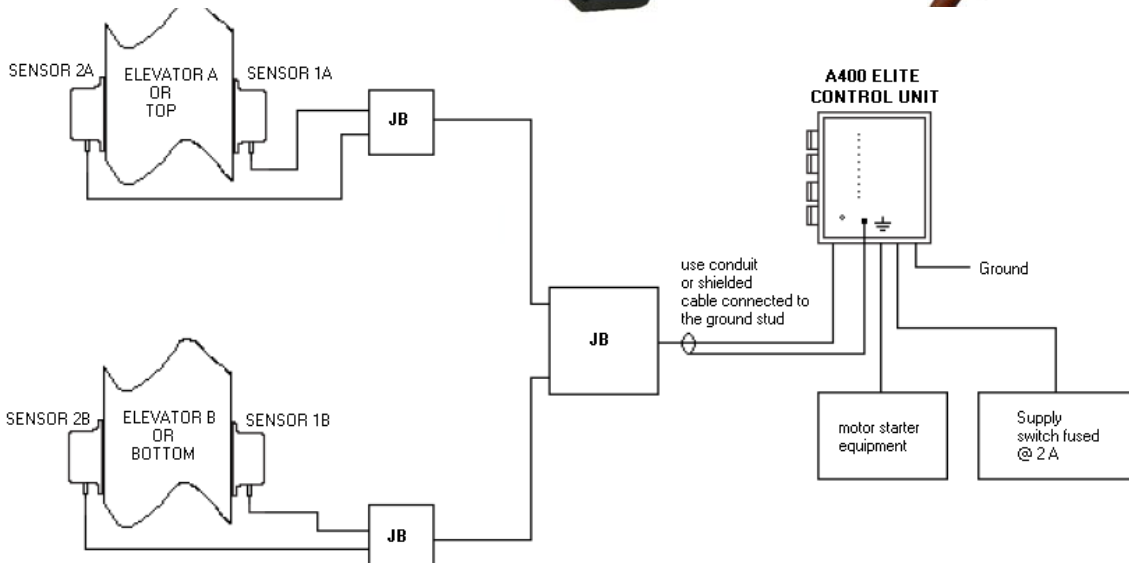

Please refer to instruction manual for correct installation. Information subject to change or correction. February 2006.